

**Direct Method<sup>1</sup>**  
**15 to 150 mg/L C (MR)**

**Method 10173**  
**Test 'N Tube™ Vials**

**Scope and application:** For water, drinking water and wastewater

<sup>1</sup> U.S. Patent 6,368,870



## Test preparation

### Instrument-specific information

Table 1 shows all of the instruments that have the program for this test. The table also shows adapter and light shield requirements for the instruments that use them.

To use the table, select an instrument, then read across to find the applicable information for this test.

**Table 1 Instrument-specific information for test tubes**

| Instrument                | Adapters                  | Light shield                       |
|---------------------------|---------------------------|------------------------------------|
| DR 6000, DR 5000          | —                         | —                                  |
| DR 3900                   | —                         | LZV849                             |
| DR 3800, DR 2800, DR 2700 | —                         | LZV646                             |
| DR 1900                   | 9609900 (D <sup>1</sup> ) | —                                  |
| DR 900                    | 4846400                   | Cover supplied with the instrument |

<sup>1</sup> The D adapter is not available with all instrument versions.

### Before starting

Install the instrument cap on the DR 900 cell holder before ZERO or READ is pushed.

DR 3900, DR 3800, DR 2800 and DR 2700: Install the light shield in Cell Compartment #2 before this test is started.

A reagent blank is required for each series of samples.

To test for higher concentrations of TOC, use Method 10128. To test for lower concentrations of TOC, use Method 10129.

Review the Safety Data Sheets (MSDS/SDS) for the chemicals that are used. Use the recommended personal protective equipment.

Dispose of reacted solutions according to local, state and federal regulations. Refer to the Safety Data Sheets for disposal information for unused reagents. Refer to the environmental, health and safety staff for your facility and/or local regulatory agencies for further disposal information.

### Items to collect

| Description   | Quantity |
|---|----------|
| Total Organic Carbon Direct Method Mid Range Test 'N Tube Reagent Set   | 1        |
| Cylinder, graduated, 10-mL  | 1        |
| DRB200 Reactor  | 1        |
| Flask, Erlenmeyer, 50-mL  | 1        |
| Light shield and adapter (For information about sample cells, adapters or light shields, refer to <a href="#">Instrument-specific information</a> on page 1.) | 1        |
| Magnetic stirrer  | 1        |
| Paper, pH   | 1        |

## Items to collect (continued)

| Description   | Quantity |
|---|----------|
| Pipet, TenSette <sup>®</sup> , 0.1- to 1.0-mL, with pipet tips  | 1        |
| Pipet, TenSette <sup>®</sup> , 1.0- to 10.0-mL, with pipet tips | 1        |
| Stir bar, magnetic  | 1        |
| Test tube rack  | 1        |
| Water, organic-free   | 3.0 mL   |
| Wipes, disposable   | 1        |

Refer to [Consumables and replacement items](#) on page 7 for order information.

## Sample collection

- Collect samples in clean glass bottles.
- Homogenize samples that contain solids to get a representative sample.
- Rinse the sample bottle several times with the sample to be collected.
- Fill the bottle completely full, then tighten the cap on the bottle.
- Analyze the samples as soon as possible for best results.
- Acid preservation is not recommended.

## Test 'N Tube procedure

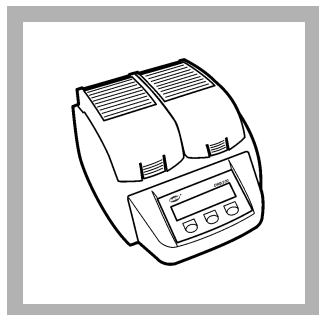

1. Start the DRB200 Reactor. Select the TOC program.

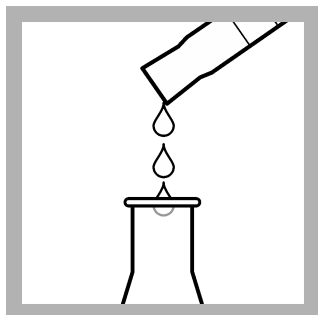

2. Add 10 mL of sample to a 50-mL Erlenmeyer flask. Put the stir bar in the Erlenmeyer flask.

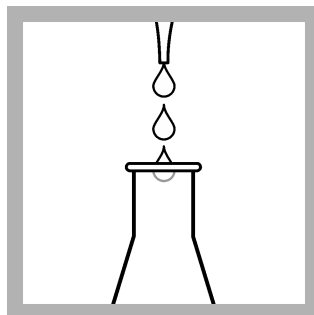

3. Add 0.4 mL of Buffer Solution to the Erlenmeyer flask, pH 2.0. Use pH paper to make sure that the sample pH is 2.

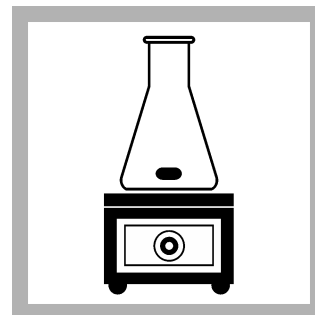

4. Put the flask on a stir plate. Stir at a moderate speed for 10 minutes.

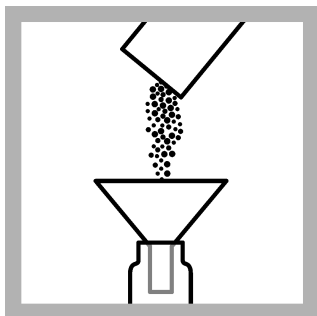

**5.** Add the contents of one TOC Persulfate Powder Pillow to each Acid Digestion Vial. Put a label that says "Reagent Blank" on one Mid Range Acid Digestion vial. Put a label that says "Sample" on a second Mid Range Acid Digestion vial.

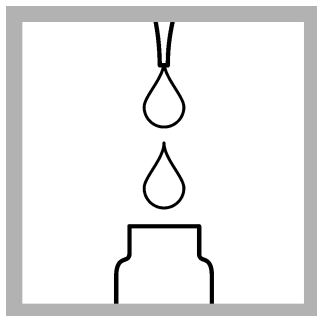

**6. Prepare the blank:** Add 1.0 mL of organic-free water to the blank vial.



**7. Prepare the sample:** Add 1.0 mL of sample from the Erlenmeyer flask to the sample vial.

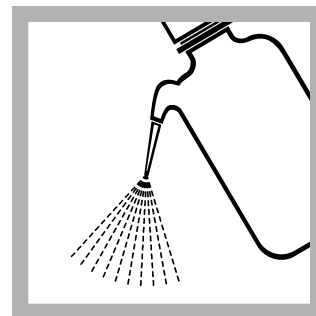

**8.** Use deionized water to rinse two blue Mid/High Range Indicator Ampules. Clean the ampules with a wipe. Do not touch the sides of the ampules after they are clean. Hold the ampules by the top.

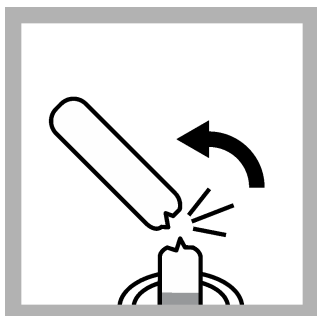

**9.** Put one unopened ampule into each Acid Digestion Vial. Snap the top off of the ampule when the score aligns with the top of the vial. Let the ampules drop into the vials. Do not invert or tilt the vials after the ampule is inside.

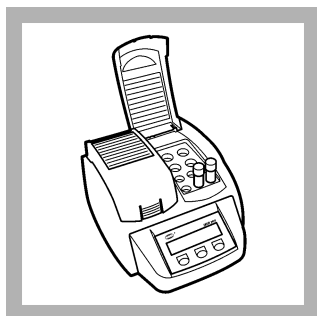

**10.** Close the vials tightly. Insert them into the reactor.

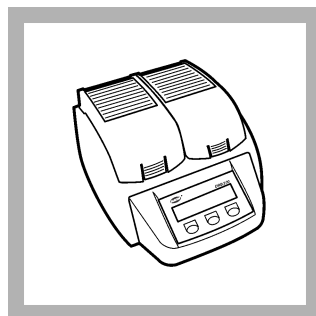

**11.** Close the reactor. Let the vials react for 2 hours at 103 to 105 °C.

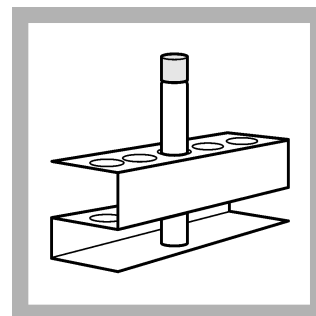

**12.** After two hours, remove the vials from the reactor. Put them in a test tube rack to cool for one hour. The liquid in the blank should show a dark blue color.

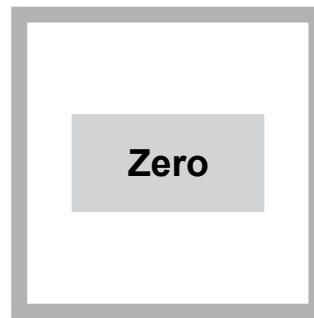
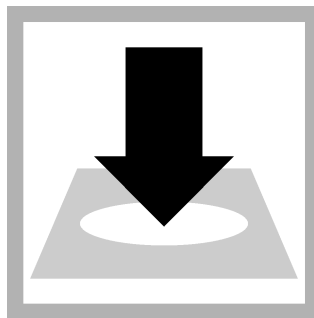
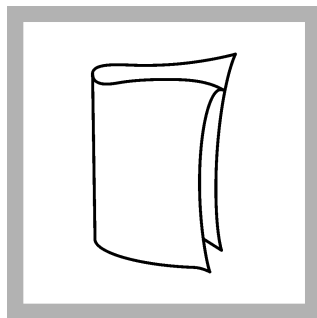
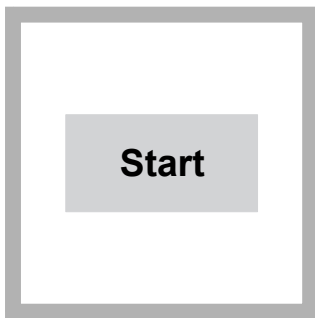

**13. Start program 425 Organic Carbon MR.** For information about sample cells, adapters or light shields, refer to [Instrument-specific information](#) on page 1.

**14. Clean the blank vial.**

**15. Insert the blank vial into the 16-mm cell holder.**

**16. Push ZERO.** The display shows 0 mg/L C.

**Note:** Although the program name can be different between instruments, the program number does not change.

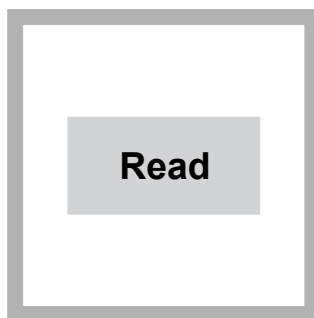
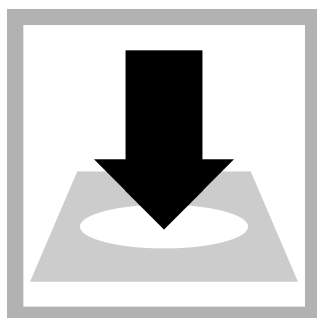
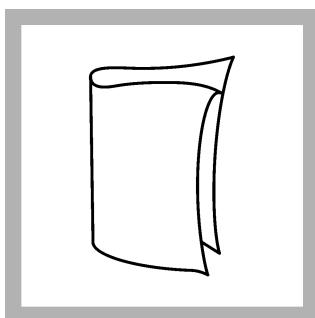

**17. Clean the sample vial.**

**18. Insert the sample vial into the 16-mm cell holder.**

**19. Push READ.** Results show in mg/L C.

## Interferences

If the sample contains more than 1000 mg/L CaCO<sub>3</sub> alkalinity, add sulfuric acid to lower the sample pH to less than 7, then start the test procedure.

Most sample turbidity is either dissolved during the digestion stage or settled during the cooling period. Sample turbidities up to 50 NTU have been tested without interference.

The table that follows shows the substances that were tested for interference and did not interfere up to the levels shown.

| Interfering substance | Interference level             |
|-----------------------|--------------------------------|
| Aluminum              | 10 mg/L Al                     |
| Ammonia Nitrogen      | 1000 mg/L as N                 |
| ASTM Wastewater       | No effect                      |
| Bromide               | 500 mg/L Br <sup>-</sup>       |
| Bromine               | 25 mg/L Br <sub>2</sub>        |
| Calcium               | 2000 mg/L as CaCO <sub>3</sub> |
| Chloride              | 1500 mg/L Cl <sup>-</sup>      |
| Chlorine              | 10 mg/L Cl <sub>2</sub>        |
| Chlorine Dioxide      | 6 mg/L ClO <sub>2</sub>        |

| Interfering substance | Interference level                            |
|-----------------------|---|
| Copper                | 10 mg/L Cu                                    |
| Cyanide               | 10 mg/L CN <sup>-</sup>                       |
| Iodide                | 50 mg/L I <sup>-</sup>                        |
| Iron (II)             | 10 mg/L Fe <sup>2+</sup>                      |
| Iron (III)            | 10 mg/L Fe <sup>3+</sup>                      |
| Magnesium             | 2000 mg/L as CaCO <sub>3</sub>                |
| Manganese (VII)       | 1 mg/L Mn                                     |
| Monochloramine        | 14 mg/L NH <sub>2</sub> Cl as Cl <sub>2</sub> |
| Nitrite               | 500 mg/L NO <sub>2</sub> <sup>-</sup>         |
| Ozone                 | 2 mg/L O <sub>3</sub>                         |
| Phosphate             | 3390 mg/L PO <sub>4</sub> <sup>3-</sup>       |
| Silica                | 100 mg/L SiO <sub>2</sub>                     |
| Sulfate               | 5000 mg/L SO <sub>4</sub> <sup>2-</sup>       |
| Sulfide               | 20 mg/L S <sup>2-</sup>                       |
| Sulfite               | 50 mg/L SO <sub>3</sub> <sup>2-</sup>         |
| Zinc                  | 5 mg/L Zn                                     |

## Reagent blank water

Water that is used for the reagent blank must contain less than 0.05 mg/L carbon. If the organic-free water container is left open for extended periods, the water can absorb carbon dioxide (CO<sub>2</sub>) from the atmosphere and contaminate the blank. To remove the dissolved CO<sub>2</sub> from the organic-free water, acidify the water and stir for 10 minutes as in the test procedure.

Generally, water that is stored in plastic containers is not suitable for low-range TOC blanks. Water that is stored in plastic can become contaminated with organic compounds from the container walls. These leached organic compounds usually cannot be removed by the acid-sparge process.

## Accuracy check

### Standard additions method (sample spike)

Use the standard additions method (for applicable instruments) to validate the test procedure, reagents and instrument and to find if there is an interference in the sample.

Items to collect:

- TOC Standard Solution Ampule, 1000 mg/L C
- 50-mL volumetric flask, Class A
- 15-mL volumetric pipet and pipet filler
- Organic-free water
- Pipet, TenSette®, 0.1–1.0 mL and tips

1. Prepare a 300-mg/L total organic carbon standard solution as follows:
  - a. Use a pipet to add 15.00 mL of a 1000 mg/L TOC standard solution into the volumetric flask.
  - b. Dilute to the mark with organic-free water. Mix well. Prepare this solution daily.
2. Use the test procedure to measure the concentration of the sample, then keep the (unspiked) sample in the instrument.
3. Go to the Standard Additions option in the instrument menu.

4. Select the values for standard concentration, sample volume and spike volumes.
5. Prepare three spiked samples: use the TenSette pipet to add 0.1 mL, 0.2 mL and 0.3 mL of the prepared standard solution, respectively, to three Acid Digestion Vials.
6. Add the contents of one TOC Persulfate Powder Pillow to each vial.
7. Add 1.0 mL of sample to each vial. Swirl to mix.
8. Use the test procedure to measure the concentration of each of the spiked samples. Start with the smallest sample spike. Measure each of the spiked samples in the instrument.
9. Select **Graph** to compare the expected results to the actual results.

*Note: If the actual results are significantly different from the expected results, make sure that the sample volumes and sample spikes are measured accurately. The sample volumes and sample spikes that are used should agree with the selections in the standard additions menu. If the results are not within acceptable limits, the sample may contain an interference.*

### Standard solution method

Use the standard solution method to validate the test procedure, the reagents and the instrument.

Items to collect:

- TOC Standard Solution Ampule 1000 mg/L C
  - 50-mL volumetric flask, Class A
  - 5-mL volumetric pipet, Class A and pipet filler
  - Organic-free reagent water
1. Prepare a 100 mg/L C standard solution as follows:
    - a. Use a pipet to add 5.00 mL of 1000 mg/L total organic carbon standard solution into the volumetric flask.
    - b. Dilute to the mark with organic-free reagent water. Mix well. Prepare this solution daily.
  2. Use the test procedure to measure the concentration of the prepared standard solution.
  3. Compare the expected result to the actual result.

*Note: The factory calibration can be adjusted slightly with the standard adjust option so that the instrument shows the expected value of the standard solution. The adjusted calibration is then used for all test results. This adjustment can increase the test accuracy when there are slight variations in the reagents or instruments.*

### Method performance

The method performance data that follows was derived from laboratory tests that were measured on a spectrophotometer during ideal test conditions. Users can get different results under different test conditions.

| Program | Standard  | Precision (95% confidence interval) | Sensitivity<br>Concentration change per 0.010 Abs change |
|---------|-----------|-------------------------------------|--|
| 425     | 70 mg/L C | 68–72 mg/L C                        | 1.2 mg/L C   |

### Summary of method

The total organic carbon (TOC) concentration is determined by first sparging the sample under slightly acidic conditions to remove the inorganic carbon. In the outside vial, organic carbon in the sample is digested by persulfate and acid to form carbon dioxide. During digestion, the carbon dioxide diffuses into a pH indicator reagent in the inner ampule. The absorption of carbon dioxide into the indicator forms carbonic acid. Carbonic acid changes the pH and thus the color of the indicator solution. The amount of color change is related to the original amount of carbon in the sample. The measurement wavelengths are 598 and 430 nm for spectrophotometers or 610 nm for colorimeters.

## Consumables and replacement items

### Required reagents

| Description   | Quantity/test | Unit     | Item no. |
|---|---------------|----------|----------|
| pH Paper  | 1             | 5/pkg    | 39133    |
| Water, organic-free   | 3.0 mL        | 500 mL   | 2641549  |
| Reagent Set, Total Organic Carbon Direct Method Mid Range Test 'N Tube™ | —             | 50 vials | 2815945  |
| Includes:   |               |          |          |
| Acid Digestion Solution Vials, High Range TOC (not sold separately)     | 1             | 50/pkg   | —        |
| Buffer Solution (not sold separately; see alternate size below)         | 0.4 mL        | 25 mL    | —        |
| Funnel, micro, poly   | 1             | each     | 2584335  |
| Indicator Ampule, MR/HR TOC (not sold separately)                       | 1             | 10/pkg   | —        |
| TOC Persulfate Powder Pillows (not sold separately)                     | 1             | 50/pkg   | —        |

### Required apparatus

| Description                                       | Quantity/test | Unit    | Item no.        |
|---|---------------|---------|-----------------|
| Cylinder, graduated, 10-mL                        | 1             | each    | 50838           |
| DRB 200 Reactor, 110 VAC option, 15 x 16-mm wells | 1             | each    | LTV082.53.40001 |
| OR  |               |         |                 |
| DRB 200 Reactor, 220 VAC option, 15 x 16-mm wells | 1             | each    | LTV082.52.40001 |
| Flask, Erlenmeyer, 50-mL                          | 1             | each    | 50541           |
| Magnetic Stirrer                                  | 1             | each    | 2881200         |
| Pipet, TenSette®, 0.1–1.0 mL                      | 1             | each    | 1970001         |
| Pipet Tips, for TenSette® Pipet, 0.1–1.0 mL       | 2             | 50/pkg  | 2185696         |
| Pipet, TenSette® 1.0–10.0 mL                      | 1             | each    | 1970010         |
| Pipet Tips, for TenSette® Pipet, 1.0–10.0 mL      | varies        | 50/pkg  | 2199796         |
| Stir bar, magnetic                                | 1             | each    | 4531500         |
| Test tube rack                                    | 1             | each    | 1864100         |
| Wipes, disposable                                 | 1             | 280/pkg | 2097000         |

### Recommended standards

| Description  | Unit  | Item no. |
|--|-------|----------|
| TOC Standard Solution Ampule (KHP Standard, 1000-mg/L C) | 5/pkg | 2791505  |

### Optional reagents and apparatus

| Description                                    | Unit     | Item no. |
|--|----------|----------|
| Balance, analytical, 80 g x 0.1 mg 100–240 VAC | each     | 2936701  |
| Buffer Solution, Sulfate pH 2.0                | 500 mL   | 45249    |
| Flask, volumetric, 50-mL                       | each     | 1457441  |
| Flask, volumetric, Class A, 1000-mL glass      | each     | 1457453  |
| Pipet tips for TenSette® Pipet, 0.1–1.0 mL     | 1000/pkg | 2185628  |

**Optional reagents and apparatus (continued)**

| <b>Description</b>                          | <b>Unit</b> | <b>Item no.</b> |
|---|-------------|-----------------|
| Pipet tips for TenSette® Pipet, 1.0–10.0 mL | 250/pkg     | 2199725         |
| Paper, for weighing, 100 x 100 mm           | 500/pkg     | 1473885         |
| Pipet, volumetric Class A, 15-mL            | each        | 1451539         |
| Pipet, volumetric, Class A, 5.00-mL         | each        | 1451537         |
| Pipet filler, safety bulb                   | each        | 1465100         |
| Potassium Acid Phthalate (KHP), ACS         | 500 g       | 31534           |
| Sulfuric Acid Standard Solution, 5.25 N     | 100 mL      | 244932          |



**FOR TECHNICAL ASSISTANCE, PRICE INFORMATION AND ORDERING:**  
In the U.S.A. – Call toll-free 800-227-4224  
Outside the U.S.A. – Contact the HACH office or distributor serving you.  
On the Worldwide Web – [www.hach.com](http://www.hach.com); E-mail – [techhelp@hach.com](mailto:techhelp@hach.com)

**HACH COMPANY**  
WORLD HEADQUARTERS  
Telephone: (970) 669-3050  
FAX: (970) 669-2932