

# Chlorine, Free and Total, Mid-Range

DOC316.53.01451

USEPA DPD Method<sup>1</sup>

Method 10245 (Free) 10250 (Total)

0.05 to 4.00 mg/L Cl<sub>2</sub> (MR)

Powder Pillows

**Scope and application:** For testing free chlorine (hypochlorous acid and hypochlorite ion) in water and treated waters. For testing total chlorine in water, treated waters and wastewater.<sup>2</sup> This product has not been evaluated to test for chlorine and chloramines in medical applications in the United States.

<sup>1</sup> USEPA accepted for reporting wastewater and drinking water analyses.

<sup>2</sup> Procedure is equivalent to USEPA method 330.5 for wastewater and Standard Method 4500-Cl G for drinking water.



## Test preparation

### Before starting

Analyze the samples immediately. The samples cannot be preserved for later analysis.

Always do tests in sample cells. Do not put the instrument in the sample or pour the sample into the cell holder.

Make sure that the sample cells are clean and there are no scratches where the light passes through them.

Rinse the sample cell and cap with the sample three times before the sample cell is filled.

Make sure that there are no fingerprints or liquid on the external surface of the sample cells. Wipe with a lint-free cloth before measurement.

Cold waters can cause condensation on the sample cell or bubbles in the sample cell during color development. Examine the sample cell for condensation or bubbles. Remove condensation with a lint-free cloth. Invert the sample cell to remove bubbles.

Install the instrument cap over the cell holder before ZERO or READ is pushed.

Do not use the same sample cells for free and total chlorine. If trace iodide from the total chlorine reagent is carried over into the free chlorine determination, monochloramine will interfere. It is best to use separate, dedicated sample cells for free and total chlorine measurements.

If the test result is over-range, or if the sample temporarily turns yellow after the reagent addition, dilute the sample with a known volume of high quality, chlorine demand-free water and do the test again. Some loss of chlorine may occur due to the dilution. Multiply the result by the dilution factor. Additional methods are available to measure chlorine without dilution.

After the test, immediately empty and rinse the sample cell. Rinse the sample cell and cap three times with deionized water.

For the best results, measure the reagent blank value for each new lot of reagent. Replace the sample with deionized water in the test procedure to determine the reagent blank value. Subtract the reagent blank value from the sample results.

Review the Safety Data Sheets (MSDS/SDS) for the chemicals that are used. Use the recommended personal protective equipment.

Dispose of reacted solutions according to local, state and federal regulations. Refer to the Safety Data Sheets for disposal information for unused reagents. Refer to the environmental, health and safety staff for your facility and/or local regulatory agencies for further disposal information.

### Items to collect

Description	Quantity
Chlorine, Free: DPD Free Chlorine Reagent Powder Pillows, 25-mL	1
Chlorine, Total: DPD Total Chlorine Reagent Powder Pillows, 25-mL	1
Sample cells, 25-mm (10 mL)	2

Refer to [Consumables and replacement items](#) on page 6 for order information.

## Sample collection

- Analyze the samples immediately. The samples cannot be preserved for later analysis.
- Chlorine is a strong oxidizing agent and is unstable in natural waters. Chlorine reacts quickly with various inorganic compounds and more slowly with organic compounds. Many factors, including reactant concentrations, sunlight, pH, temperature and salinity influence the decomposition of chlorine in water.
- Collect samples in clean glass bottles. Do not use plastic containers because these can have a large chlorine demand.
- Pretreat glass sample containers to remove chlorine demand. Soak the containers in a weak bleach solution (1 mL commercial bleach to 1 liter of deionized water) for at least 1 hour. Rinse fully with deionized or distilled water. If sample containers are rinsed fully with deionized or distilled water after use, only occasional pretreatment is necessary.
- Make sure to get a representative sample. If the sample is taken from a spigot or faucet, let the water flow for at least 5 minutes. Let the container overflow with the sample several times and then put the cap on the sample container so that there is no headspace (air) above the sample.

## Powder pillow procedure

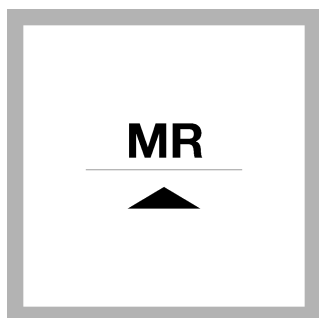

**1. Set the instrument to mid-range (MR).**  
For DR300, push the up arrow button. For PCII, push the menu button, checkmark button, then the menu button again.

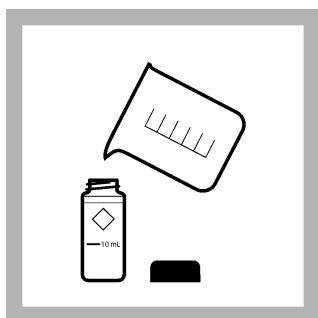

**2. Prepare the blank:**  
Rinse a sample cell and cap three times with sample. Fill the sample cell to the 10-mL mark with sample. Close the sample cell.

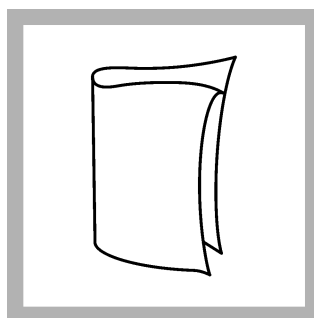

**3. Clean the blank sample cell.**

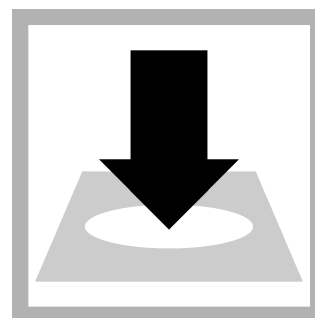

**4. Insert the blank into the cell holder.** Point the diamond mark on the sample cell toward the keypad.

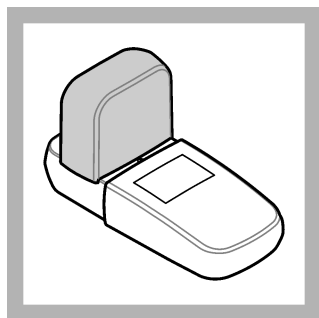

**5. Install the instrument cap over the cell holder.**

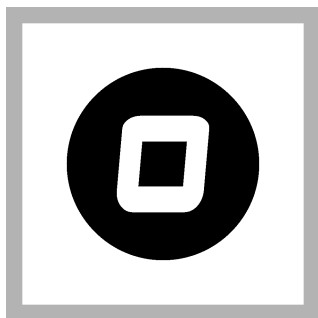

**6. Push ZERO.** The display shows "0.00".

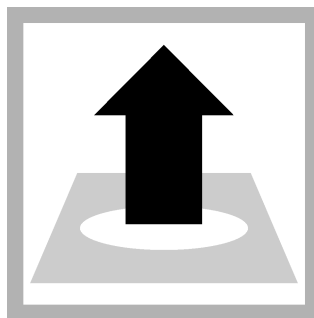

**7. Remove the sample cell from the cell holder.**



**8. Prepare the sample:**  
Rinse a second sample cell and cap three times with sample. Fill the sample cell to the 10-mL mark with sample.

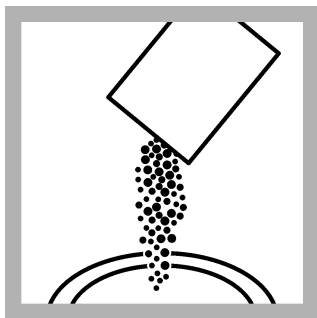

**9.** Add one 25-mL DPD Free Chlorine Reagent Powder Pillow or one 25-mL DPD Total Chlorine Reagent Powder Pillow to the second sample cell.

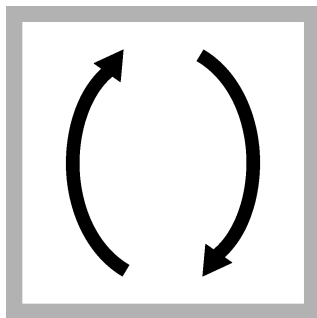

**10.** Close the sample cell. Invert the sample cell for about **20 seconds** to dissolve the reagent. Undissolved powder will not affect accuracy. A pink color will show if chlorine is in the sample.

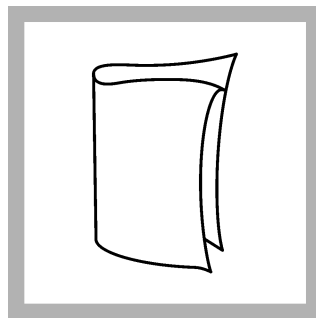

**11.** Clean the prepared sample cell.

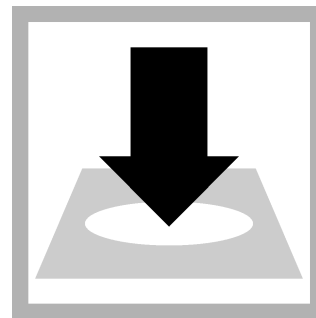

**12. Free chlorine measurement:** Within 1 minute of the reagent addition, insert the prepared sample into the cell holder. Point the diamond mark on the sample cell toward the keypad. Go to step [15](#).



**13.** Set and start a timer for 3 minutes. A 3-minute reaction time starts.

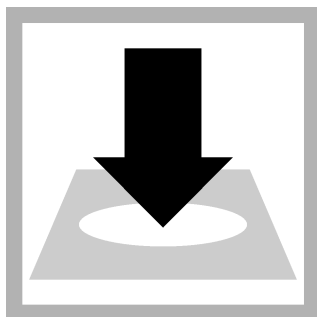

**14. Total chlorine measurement:** After 3 minutes and within 6 minutes of the reagent addition, insert the prepared sample into the cell holder. Point the diamond mark on the sample cell toward the keypad.

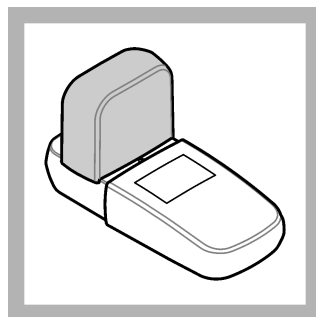

**15.** Install the instrument cap over the cell holder.

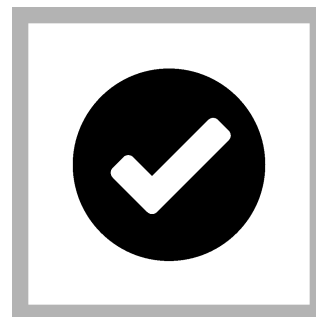

**16.** Push **READ**. Results show in mg/L Cl<sub>2</sub>.

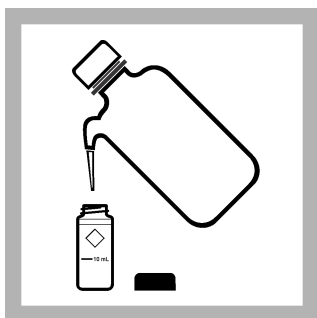

**17.** Immediately empty the sample cell. Rinse the sample cell and cap three times with deionized water.

## Interferences

Interfering substance	Interference level
Acidity	More than 150 mg/L CaCO <sub>3</sub> . The full color may not develop or the color may fade instantly. Adjust to pH 6–7 with 1 N Sodium Hydroxide. Measure the amount to be added on a separate sample aliquot, then add the same amount to the sample that is tested. Correct the test result for the dilution from the volume addition.
Alkalinity	More than 250 mg/L CaCO <sub>3</sub> . The full color may not develop or the color may fade instantly. Adjust to pH 6–7 with 1 N Sulfuric Acid. Measure the amount to add on a separate sample aliquot, then add the same amount to the sample that is tested. Correct the test result for the dilution from the volume addition.
Bromine, Br <sub>2</sub>	Interferes at all levels
Chlorine Dioxide, ClO <sub>2</sub>	Interferes at all levels
Chloramines, organic	May interfere
Hardness	No effect at less than 1000 mg/L as CaCO <sub>3</sub>
Iodine, I <sub>2</sub>	Interferes at all levels
Manganese, Oxidized (Mn <sup>4+</sup> , Mn <sup>7+</sup> ) or Chromium, Oxidized (Cr <sup>6+</sup> )	Pre-treat the sample as follows: <ol style="list-style-type: none"> <li>1. Adjust the sample pH to 6–7.</li> <li>2. Add 3 drops of Potassium Iodide (30-g/L) to 10 mL of sample.</li> <li>3. Mix and wait 1 minute.</li> <li>4. Add 3 drops of Sodium Arsenite (5-g/L) and mix.</li> <li>5. Use the test procedure to measure the concentration of the treated sample.</li> <li>6. Subtract this result from the result without the treatment to obtain the correct chlorine concentration.</li> </ol>
Monochloramine	For conventional free chlorine disinfection (beyond the breakpoint), monochloramine concentrations are very low. If monochloramine is in the sample, its interference in the free chlorine test changes with the temperature, the relative amount of monochloramine to free ammonia and the time necessary to do the analysis. <a href="#">Table 1</a> gives the approximate interference levels of monochloramine in the free chlorine test as mg/L Cl <sub>2</sub> .
Ozone	Interferes at all levels
Peroxides	May interfere
Highly buffered samples or extreme sample pH	Can prevent the correct pH adjustment (of the sample) by the reagents. Sample pretreatment may be necessary. Adjust to pH 6–7 with acid (Sulfuric Acid, 1 N) or base (Sodium Hydroxide, 1 N). Correct the test result for the dilution caused by the volume additions.

**Table 1 Monochloramine level versus temperature**

NH <sub>2</sub> Cl (as Cl <sub>2</sub> )	Sample temperature			
	5 °C (40 °F)	10 °C (50 °F)	20 °C (68 °F)	30 °C (83 °F)
1.2	0.2	0.2	0.3	0.3
2.5	0.4	0.5	0.6	0.6
3.5	0.5	0.6	0.7	0.8

## Pollution prevention and waste management

If sodium arsenite was added to the sample for manganese or chromium interferences, the reacted samples will contain arsenic and must be disposed of as a hazardous waste. Dispose of reacted solutions according to local, state and federal regulations. must be disposed of as a hazardous waste. Dispose of reacted solutions according to local, state and federal regulations.

---

## Accuracy check

### Standard additions method

Use the standard additions method to validate the test procedure, reagents and instrument and to find if there is an interference in the sample.

Items to collect:

- Chlorine Standard Solution, 2-mL PourRite<sup>®</sup> Ampule, 50–75 mg/L (use mg/L on label)
  - Ampule breaker
  - Pipet, TenSette<sup>®</sup>, 0.1–1.0 mL and tips
1. Prepare three spiked samples: use the TenSette pipet to add 0.1 mL, 0.2 mL and 0.3 mL of the standard solution, respectively, to three 10-mL portions of fresh sample. Mix well.
  2. Use the test procedure to measure the concentration of each of the spiked samples. Start with the smallest sample spike. Measure each of the spiked samples in the instrument.
  3. Compare the expected result to the actual result. The expected increase in the chlorine concentration is the Cl<sub>2</sub> mg/L concentration from the label of the standard solution multiplied by 0.1 mL for every 10 mL of standard solution added.

### Standard solution method

If the Standard Calibration Adjust feature is used to adjust the calibration curve of the DR300 or Pocket Colorimeter II, the concentration of the chlorine standard must be between 1.00 and 3.00 mg/L chlorine for the MR procedure.

### Verification of on-line analyzers

This procedure can be used to meet the requirements of USEPA Method 334.0 - Determination of Residual Chlorine in Drinking Water Using an On-line Chlorine Analyzer. The procedure and requirements for compliance with EPA Method 334.0 can be downloaded directly from <http://www.hach.com/method334>.

### Method performance

The method performance data that follows was derived from laboratory tests that were measured on a DR300 and a Pocket Colorimeter II during ideal test conditions. Users can get different results under different test conditions.

Precision (95% confidence interval)
2.00 ± 0.09 mg/L Cl <sub>2</sub>

### Summary of method

Chlorine can be in water as free chlorine and as combined chlorine. Both forms can be in the same solution and can be determined together as total chlorine. Free chlorine is in a solution as hypochlorous acid or hypochlorite ion. Combined chlorine represents a combination of chlorine-containing compounds, including monochloramine, dichloramine, nitrogen trichloride and other chloro derivatives. The combined chlorine oxidizes iodide (I<sup>-</sup>) to iodine (I<sub>2</sub>). The iodine and free chlorine reacts with DPD (N,N-diethyl-p-phenylenediamine) to form a red solution. The color intensity is proportional to the chlorine concentration. To determine the concentration of combined chlorine, complete a free chlorine test and a total chlorine test. Subtract the results of the free chlorine test from the total chlorine test to get the combined chlorine concentration.

## Consumables and replacement items

### Required reagents

Description	Quantity/test	Unit	Item no.
DPD Free Chlorine Reagent Powder Pillow, 25 mL	1	100/pkg	1407099
DPD Total Chlorine Reagent Powder Pillow, 25 mL	1	100/pkg	1406499

### Required apparatus

Description	Quantity/test	Unit	Item no.
Sample cells, 10-mL round, 25 mm x 60 mm	2	6/pkg	2427606

### Recommended standards and apparatus

Description	Unit	Item no.
Chlorine Standard Solution, 2-mL PourRite <sup>®</sup> Ampules, 50–75 mg/L	20/pkg	1426820
Chlorine Standard Solution, 10-mL Voluette <sup>®</sup> Ampule, 50–75 mg/L	16/pkg	1426810
Ampule Breaker, 10-mL Voluette <sup>®</sup> Ampules	each	2196800
PourRite <sup>®</sup> Ampule Breaker, 2-mL	each	2484600

### Optional reagents and apparatus

Description	Unit	Item no.
Mixing cylinder, graduated, 25-mL	each	2088640
Potassium Iodide, 30-g/L	100 mL	34332
Sodium Arsenite, 5-g/L	100 mL	104732
Sodium Hydroxide Standard Solution, 1.0 N	100 mL MDB	104532
Sulfuric Acid Standard Solution, 1 N	100 mL MDB	127032
Pipet, TenSette <sup>®</sup> , 0.1–1.0 mL	each	1970001
Pipet tips for TenSette <sup>®</sup> Pipet, 0.1–1.0 mL	50/pkg	2185696
Pipet tips for TenSette <sup>®</sup> Pipet, 0.1–1.0 mL	1000/pkg	2185628
Paper, pH, 0–14 pH range	100/pkg	2601300
DPD Free Chlorine Reagent Powder Pillows, 25 mL	1000/pkg	1407028
DPD Total Chlorine Reagent Powder Pillows, 25 mL	1000/pkg	1406428
SpecCheck <sup>™</sup> Secondary Standard Kit, Chlorine DPD, MR	each	2980500
Water, organic-free	500 mL	2641549



FOR TECHNICAL ASSISTANCE, PRICE INFORMATION AND ORDERING:  
In the U.S.A. – Call toll-free 800-227-4224  
Outside the U.S.A. – Contact the HACH office or distributor serving you.  
On the Worldwide Web – [www.hach.com](http://www.hach.com); E-mail – [techhelp@hach.com](mailto:techhelp@hach.com)

HACH COMPANY  
WORLD HEADQUARTERS  
Telephone: (970) 669-3050  
FAX: (970) 669-2932