

Immunoassay¹

Method 10050

Scope and application: For soil and water.

¹ This test is semi-quantitative. Results are shown as more or less than the threshold value used.



Test preparation

Before starting

This method analyzes for TPH in soil or water samples. For soil analysis, do the Soil Extraction procedure before the Immunoassay procedure. For water analysis, start with the Immunoassay procedure. The test requires about 20 to 30 minutes for complete analysis.

The Immunoassay instruments give a reading in terms of absorbance. Use the absorbance reading to compare samples to the calibrators.

Before the procedure starts, read the full procedure. Identify and prepare all the necessary reagents, cuvettes and other apparatus, then start the procedure.

Timing is very important in this procedure. Follow the instructions carefully.

It is very important to use a consistent technique to mix the solution in the cuvettes. Refer to [Use of the 12-mm MicroCuvette rack](#) on page 6. If the cuvettes are individually mixed, the results can be less consistent.

Be careful with the cuvettes. A scratch on the inner or outer cuvette surfaces can cause incorrect results. Carefully clean the outer surfaces with a clean, absorbent cloth or tissue before use.

Antibody cuvettes and enzyme conjugate are made in matched lots. Do not mix reagent lots.

Keep the color developing solution out of direct sunlight to prevent deterioration.

The cuvette rack can be inverted with the cuvettes in the rack. This lets the user prepare many samples at the same time. The cuvettes stay in the rack until the results are read in the instrument.

The recommended temperature for reagent storage is 4 °C (39.2 °F). Let the reagent temperature increase to room temperature before analysis.

The Soil Extractant contains methyl alcohol, which is poisonous and flammable. Review the Safety Data Sheets (MSDS/SDS) for the chemicals that are used. Use the recommended personal protective equipment.

Each reagent set has 20 antibody cuvettes. Use one antibody cuvette for each calibrator and each sample. Cuvettes are not reusable.

Use protective nitrile gloves for this procedure.

Review the Safety Data Sheets (MSDS/SDS) for the chemicals that are used. Use the recommended personal protective equipment.

Dispose of reacted solutions according to local, state and federal regulations. Refer to the Safety Data Sheets for disposal information for unused reagents. Refer to the environmental, health and safety staff for your facility and/or local regulatory agencies for further disposal information.

Items to collect

Description	Quantity
TPH Reagent Set	1
Caps, flip spout	1
Cylinder, graduated 10-mL	1
Marker, laboratory	1
Pipet, TenSette, 0.1–1.0 mL	1
Pipet tips, for TenSette Pipet, 0.1–1.0-mL	1

Items to collect (continued)

Description	Quantity
Rack, for 12-mm Micro Cuvettes	1
Scoop, 5 g	1
Soil extraction kit	varies
Water, deionized	varies
Wipes, disposable	1
Wiretrol pipet	1

Refer to [Consumables and replacement items](#) on page 9 for order information.

Sample collection and storage

- Analyze the samples as soon as possible for best results.
- If sample storage is necessary, collect the samples in glass or PTFE containers. Clean the containers with soap and water, then rinse the containers with methanol. Use PTFE-lined caps for the containers. If PTFE-lined caps are not available, use aluminum foil as a substitute cap liner. Rinse the aluminum foil with methanol before use.
- For water samples, completely fill the container (no head space) and immediately tighten the cap.
- Keep soil samples in storage at 6 °C (43 °F) for a maximum of 14 days.
- Keep water samples in storage for a maximum of 24 hours. Put the sample in an ice bath or a refrigerator to limit the loss of volatile compounds.

Use of the Wiretrol Pipet

The Wiretrol Pipet accurately measures small quantities of liquids. The Wiretrol Pipet has two parts: a PTFE-tipped plunger and a calibrated capillary tube. The plunger can be used many times. Discard the capillary tubes after one use.

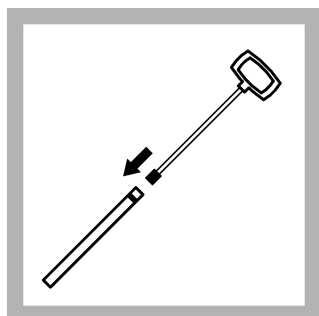

1. Make sure that the plunger tip is wet with the liquid. Carefully insert the plunger tip into the end of the capillary tube with the colored band.

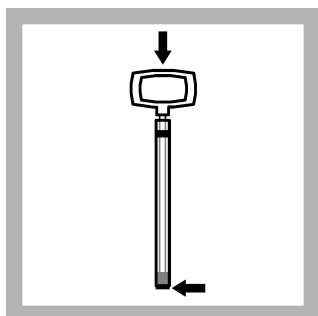

2. Push the plunger tip to the other end of the capillary tube. Stop when the plunger tip barely extends beyond the end of the capillary tube.

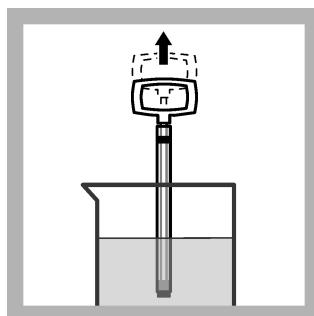

3. Insert the capillary tube below the surface of the liquid. Slowly and smoothly, pull the plunger up until the bottom of the plunger tip reaches the applicable volume line. Touch the end of the tube to the side of the vessel to release drops that remain on the capillary tube tip.

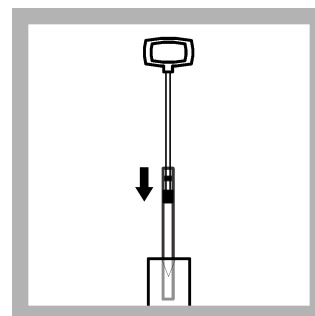

4. To release the liquid, insert the tip of the capillary tube **below the surface of the receiving solution**, and push the plunger downward in one smooth motion. Change capillary tubes for each calibrator and sample.

Soil extraction procedure

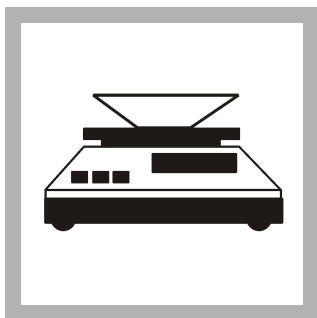

1. Weigh 10 g of soil in the plastic weighing boat.

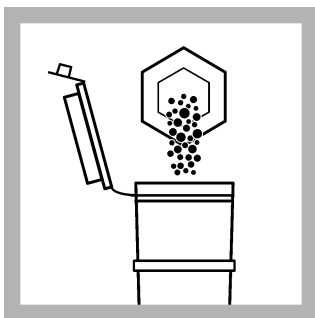

2. Carefully pour the soil into an extraction vial.

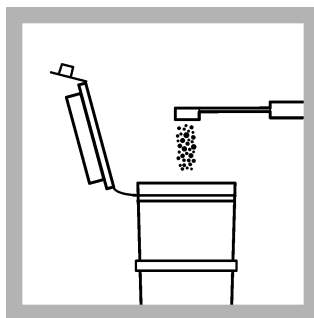

3. Use the 5-gram scoop to add one scoop of sodium sulfate to the extraction vial.

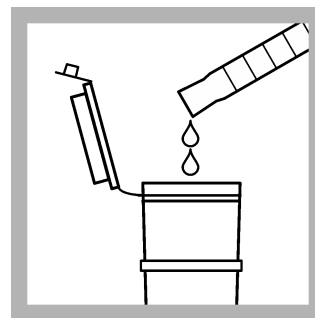

4. Use the graduated cylinder to add 10 mL of Soil Extractant into the extraction vial.

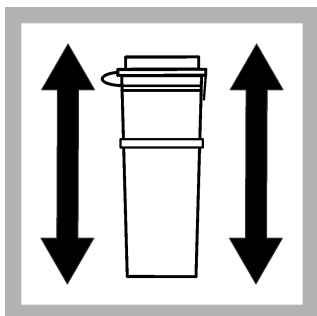

5. Put the cap on the extraction vial tightly. Shake vigorously for 1 minute.



6. Let the particles settle for a minimum of 1 minute. Carefully open the extraction vial.

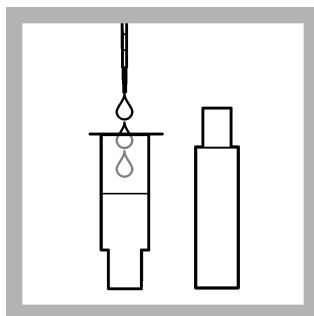

7. Use the disposable pipet to remove 1.0 to 1.5 mL from the top of the liquid layer. Add the removed liquid to the filtration barrel. Do not use more than 1.5 mL. The pipet can measure in 0.25-mL increments.

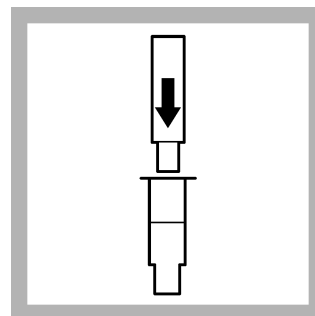

8. Put the filtration plunger into the filtration barrel. Set the filtration assembly on a table or flat surface. Push firmly on the plunger until the sample extract is forced upward into the center of the plunger. Use the resulting filtrate for the immunoassay procedure.

Immunoassay procedure

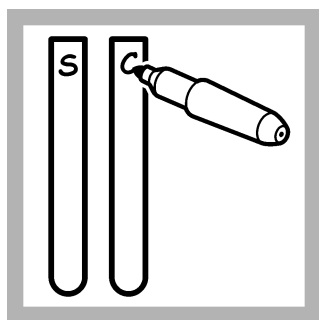

1. Put marks on the cuvettes to identify the samples and calibrators. Select the calibrator concentrations that are applicable to the expected sample concentration.

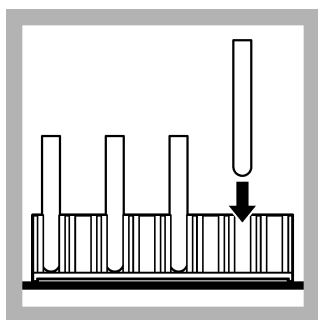

2. Insert the cuvettes into the rack. Make sure that the cuvettes are secure. Do not use force to put them into position because the cuvettes can spill or can be difficult to remove.

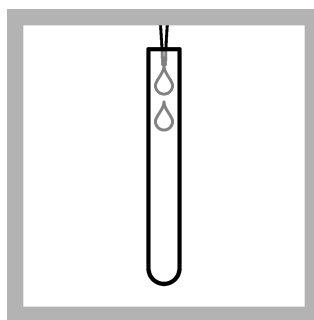

3. **Soil samples:** Use a pipet to add 0.5 mL of Diluent Solution into each calibrator and sample cuvette. The same pipette tip can be used for this step. **Water samples:** Use a pipet to add 0.5 mL of each water sample into a sample cuvette. Use a new pipet for each sample.

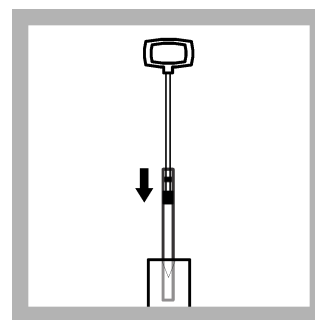

4. Use the Wiretrol pipet to add 50 μ L of each **calibrator** to the applicable calibrator cuvette. Mix the cuvettes after each addition. Use a separate capillary tube for each solution. **Have the necessary apparatus ready for this step and the next four steps. Do not wait—do these steps quickly.**

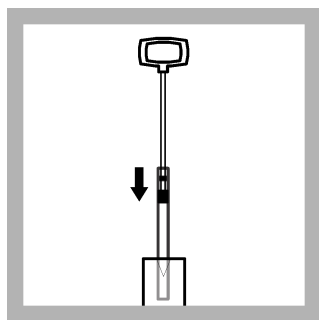

5. **Soil samples:** Use a Wiretrol pipet to add 50 μ L of the filtered extract from the soil extraction procedure. Refer to [Soil extraction procedure](#) on page 3. Use a separate capillary tube for each solution. Mix the contents of the cuvettes after each addition.

Water samples: Use a Wiretrol pipet to add 50 μ L of methanol into each sample cuvette. Mix the contents of the cuvettes after each addition.

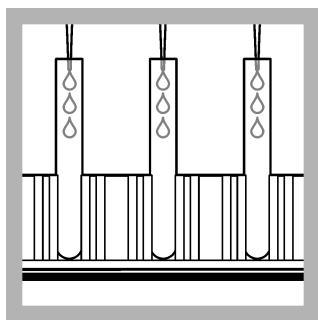

6. Immediately use a pipet to add 0.5 mL of TPH Enzyme Conjugate into each calibrator and sample cuvette. The same pipette tip can be used for this step.



7. Set and start a timer for 10 minutes. A 10-minute reaction time starts.

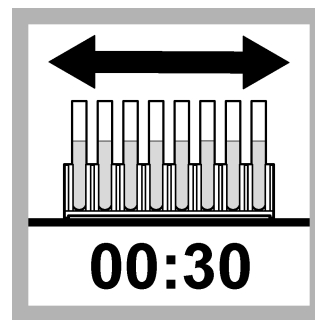

8. Immediately mix the cuvettes for 30 seconds. Refer to [Use of the 12-mm MicroCuvette rack](#) on page 6 for the correct mixing procedure.

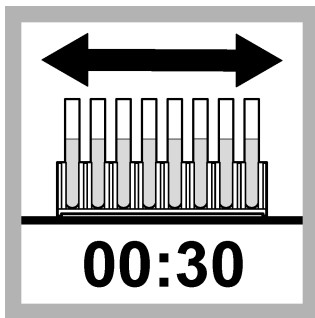

9. After 5 minutes, mix the contents of the rack a second time for 30 seconds.

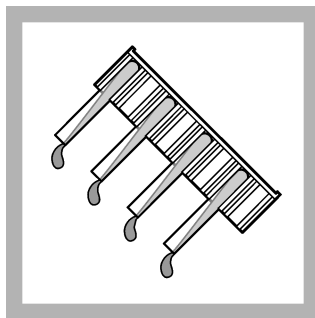

10. At the end of the 10-minute reaction period, discard the contents of all the cuvettes into a waste container for disposal.

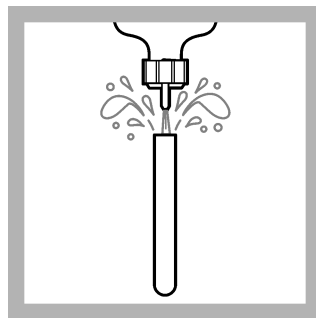

11. Fully rinse each cuvette with deionized water four times. Discard the contents into the waste container for disposal. Turn the cuvettes and rack upside down on a paper towel to dry. Carefully tap the cuvettes on the towel to remove the liquid.

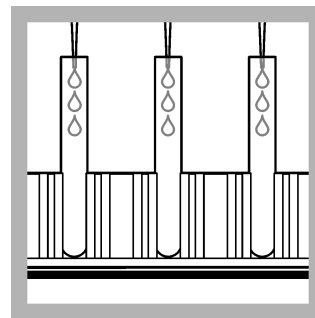

12. Start color development: Timing is very important. Make sure that the cuvettes are still in position in the rack. Use the pipet to add 0.5 mL of Color Developing Solution into each Antibody Cuvette. Use a new pipette tip for each cuvette.



13. Set and start a timer for 10 minutes. A 10-minute reaction time starts.

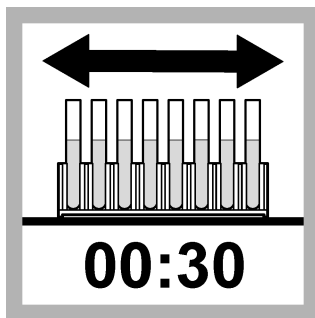

14. Immediately mix the cuvettes for 30 seconds.

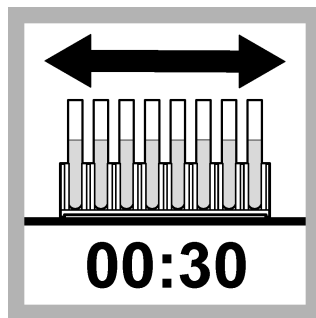

15. After 5 minutes, mix the contents of the rack a second time for 30 seconds.

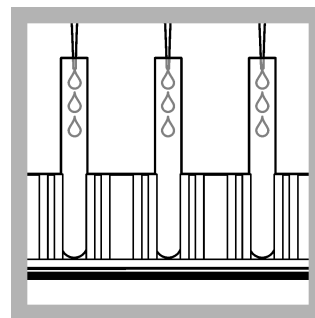

16. When the timer expires, use a pipette to add 0.5 mL of Stop Solution into each cuvette with the same pipette tip. Consistent technique is very important. Add the solution in the same sequence that was used for the Color Developing Solution addition.

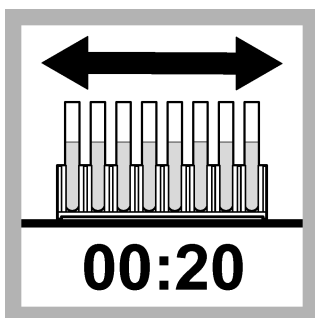

17. Slide the rack back and forth for 20 seconds. The blue solution color changes to yellow.

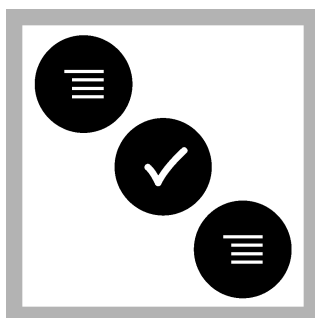

18. Set the instrument to channel 1 or channel 2. Refer to the instrument documentation. Make sure that the channel selected does not have a user-entered calibration.

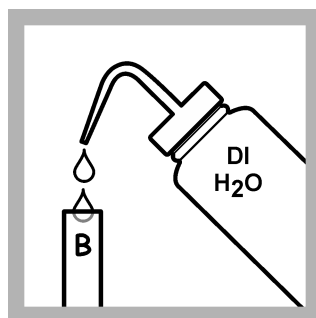

19. Put a mark on a zeroing cuvette to identify it as the blank. Fill the cuvette with deionized water.

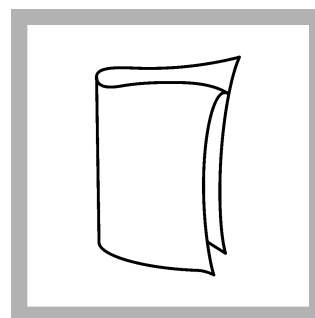

20. Clean all of the cuvettes.

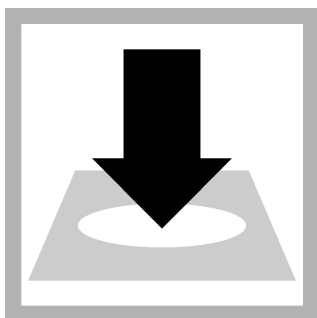

21. Insert the blank into the cell holder. Point the arrow mark on the cuvette toward the keypad.

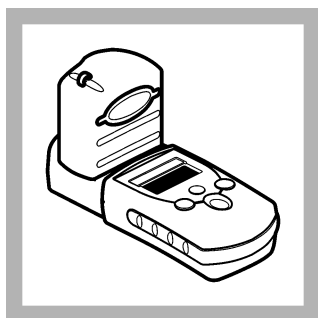

22. Install the instrument cap over the cell holder.

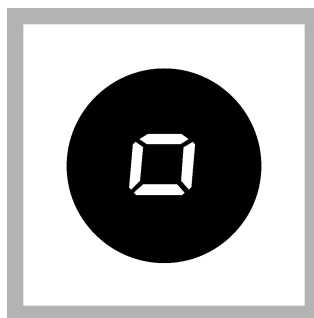

23. Push **ZERO**. The display shows “0.000”.

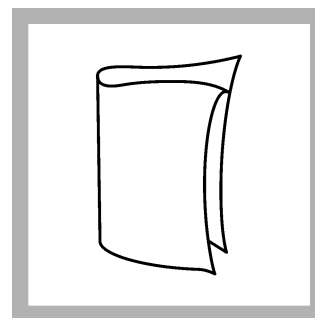

24. Clean the cuvette that contains the first calibrator.

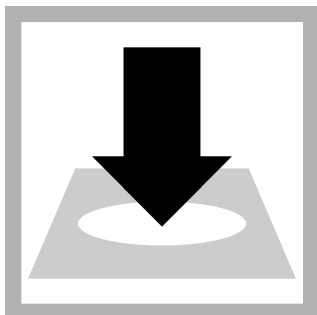

25. Insert the first calibrator into the cell holder. Point the arrow mark on the cuvette toward the keypad.

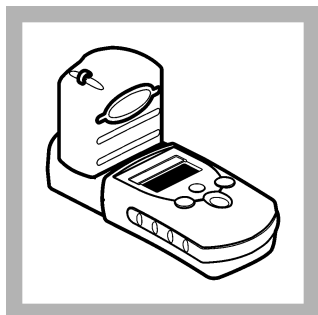

26. Install the instrument cap over the cell holder.



27. Push **READ**. Results show in absorbance units. Record the results.

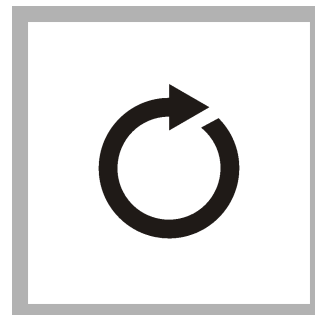

28. Read the absorbance values of the remaining calibrators and samples. Record the results. Refer to [Interpret and report the results](#) on page 7.

Interferences

Interfering substance	Interference level
Chlorine (water samples only)	Interferes above 2 ppm. To remove chlorine from the sample, add 1 drop of 0.1 N sodium thiosulfate per 100 mL of sample.

Use of the 12-mm MicroCuvette rack

Use the MicroCuvette rack to get accurate and precise results for the immunoassay procedure during the analysis of several samples at a time. Refer to [Figure 1](#).

Insert the cuvettes in the rack—Use the MicroCuvette rack to securely hold cuvettes that are set in the rack. Before the procedure starts, identify each cuvette with a sample or a calibrator number. Correctly insert the cuvettes in the rack. Do not force the cuvettes into the rack because the sample can spill or the cuvettes can be difficult to remove. The cuvettes must stay in position if the rack is inverted and carefully tapped.

Mix the sample—Put the rack on a hard, flat surface that is at least twice the length of the rack. Refer to [Figure 1](#). Hold one end of the rack, then vigorously slide the rack back and forth along its axis for 30 seconds. The rack moves through a distance equal to its own length in each direction.

Figure 1 MicroCuvette rack

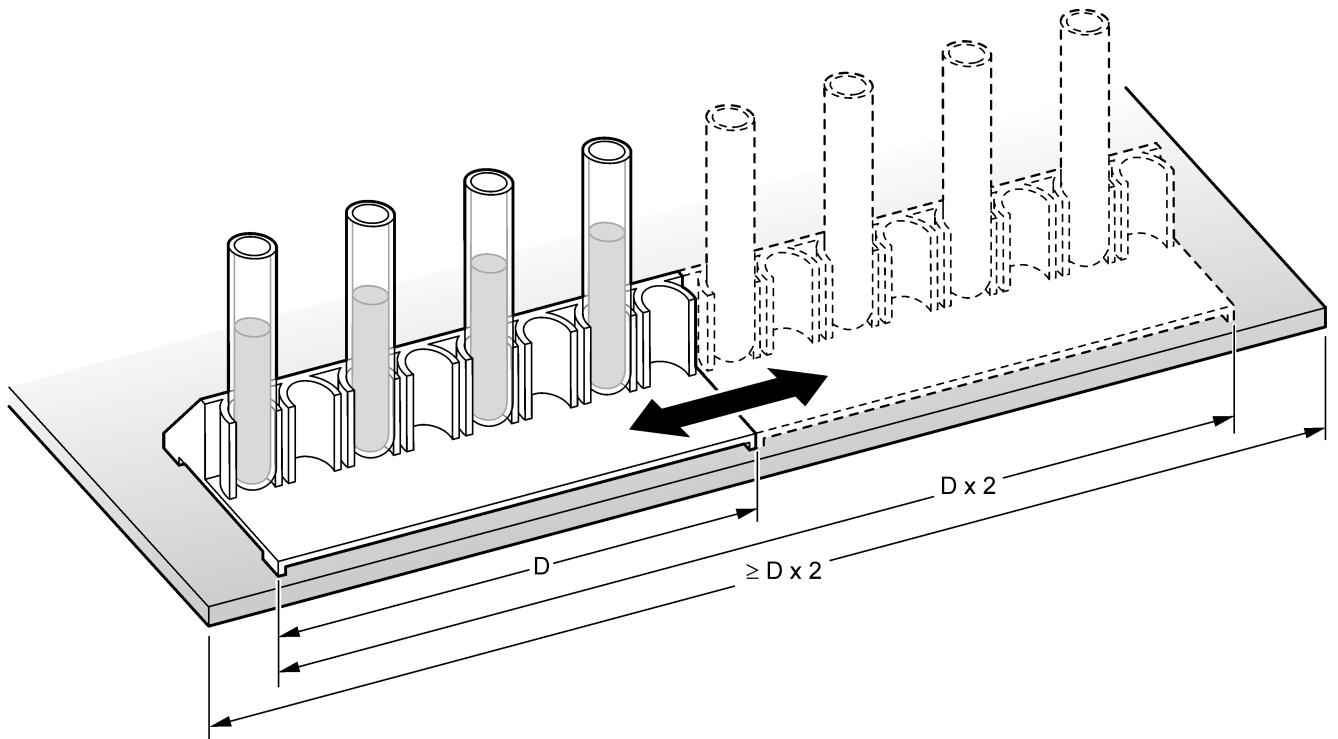

Interpret and report the results

There is an inverse relationship between the concentration of TPH and the absorbance reading. In other words, the higher the reading, the lower the concentration of TPH. Refer to [Table 1](#).

Table 1 Relative TPH concentration

If the sample absorbance reading is...	then the sample concentration is...
Smaller than the calibrator reading	Larger than the calibrator reading
Larger than the calibrator reading	Smaller than the calibrator reading

For example, if the readings are:

- TPH Calibrator 1 (20 ppm as diesel fuel): 0.480 Abs
- TPH Calibrator 2 (50 ppm as diesel fuel): 0.360 Abs
 - Sample 1: 0.200 Abs
 - Sample 2: 0.400 Abs
 - Sample 3: 0.550 Abs

The interpretation for a soil sample:

- Sample 1: The sample reading is smaller than the readings for both calibrators. The sample concentration of TPH is larger than 50 ppm diesel fuel.
- Sample 2: The sample reading is between the readings for the calibrators. The sample concentration of TPH is between 20 ppm and 50 ppm diesel fuel.
- Sample 3: The sample reading is larger than the readings for both calibrators. The sample concentration of TPH is smaller than 20 ppm diesel fuel.

The interpretation for a water sample:

- Sample 1: The sample reading is smaller than the readings for both calibrators. The sample concentration of in the sample is larger than 5 ppm diesel fuel.
- Sample 2: The sample reading is between the readings for the calibrators. The sample concentration of TPH is between 2 and 5 ppm diesel fuel.

- Sample 3: The sample reading is larger than the readings for both calibrators. The sample concentration of TPH is smaller than 2 ppm diesel fuel.

Reagent storage and handling

1. Always wear gloves and eyewear for protection.
2. For long-term storage, make sure that the reagents are not in direct sunlight. Keep the reagent set at 4 °C (39.2 °F) when not in use. Warm the reagents to room temperature before use.
3. When not in use, seal the foil pouch that contains the antibody cuvettes.
4. If the Stop Solution is in contact with the eyes, rinse fully for 15 minutes with cold water and get immediate medical help.

Sensitivity

The antibodies used in the TPH Test Kit react with a variety of compounds found in petroleum fuels. Each TPH calibrator is formulated to show a known concentration of diesel fuel. Refer to [Table 2](#) and [Table 3](#) to use calibrators for other TPH compounds.

For example, to use the TPH calibrators for gasoline, find "Gasoline" in the correct table column. Then, read across the row to find the ppm of that hydrocarbon for each calibrator. For gasoline, TPH calibrator 1 = 15 ppm, TPH calibrator 2 = 35 ppm, etc.

Table 2 TPH compounds in soil

Compound	TPH calibrator 1 (ppm)	TPH calibrator 2 (ppm)	TPH calibrator 3 (ppm)	TPH calibrator 4 (ppm)
Diesel fuel	20	50	100	200
Gasoline	15	35	70	140
Kerosene	35	75	140	250
Benzene	20	45	85	160
Toluene	15	30	50	90
Ethylbenzene	5	15	35	75
m-Xylene	9	20	35	70
o-Xylene	10	20	40	80
p-Xylene	3	5	9	16
BTEX	5	15	25	45

Table 3 TPH compounds in water

Compound	TPH calibrator 1 (ppm)	TPH calibrator 2 (ppm)	TPH calibrator 3 (ppm)	TPH calibrator 4 (ppm)
Diesel fuel	2	5	10	20
Gasoline	1.5	3.5	4	14
Kerosene	3.5	7.5	14	24
Benzene	2	4.5	8.5	16
Toluene	1.5	3	5	9
Ethylbenzene	0.5	1.5	3.5	7.5
m-Xylene	0.9	2	3.5	7
o-Xylene	1	2	4	8
p-Xylene	0.3	0.5	0.9	16
BTEX	0.5	1.5	2.5	4.5

Dilute a water sample

For higher levels of TPH in water than those shown in [Table 3](#) on page 8, dilute the sample with deionized water. To dilute a sample, refer to [Table 4](#), then add that sample volume to a graduated cylinder and dilute to 50 mL with deionized water. Do the test. Refer to [Table 3](#) on page 8 again to multiply the calibrator levels by the dilution multiplier. For example, if a 0.5 mL water sample is diluted to 50 mL, the calibrator levels in [Table 3](#) on page 8 for diesel fuel are approximately 200, 500, 1000 and 2000 ppm.

Table 4 Dilution multipliers

mL sample	Dilution multiplier
0.5	100
1.0	50
2.0	25
5.0	10
10.0	5
25.0	2

Summary of method

This method is the semi-quantitative screening for TPH based on thresholds as diesel fuel in the concentrations that follow:

- Soil—20, 50, 100, 200 ppm as diesel fuel
- Water—2, 5, 10, 20 ppm as diesel fuel

Immunoassay tests use antigen/antibody reactions to detect specific organic compounds in water and soil. The walls of plastic cuvettes are layered with antibodies that are specific for atrazine. The antibodies selectively remove TPH from complex sample matrices. A prepared sample and a reagent with enzyme-conjugate molecules (analyte molecules attached to molecules of an enzyme) are added to the Antibody Cuvettes. During incubation, enzyme-conjugate molecules and TPH compete for binding sites on the antibodies. Samples with higher levels of analyte have more antibody sites occupied by the analyte and fewer antibody sites occupied by the enzyme-conjugate molecules.

After incubation, the sample and unbound enzyme conjugate are rinsed from the cuvette and a color-development reagent is added. The enzyme in the conjugate catalyzes the development of color. Thus, there is an inverse relationship between color intensity and the amount of TPH in the sample. The resulting color is then compared with a calibrator to determine if the analyte concentration in the sample is larger or smaller than the threshold levels. The TPH concentration is inversely proportional to the color development—the lighter the color, the higher the TPH concentration. The test results are measured at 450 nm.

Consumables and replacement items

Required reagents

Description	Quantity/Test	Unit	Item no.
Soil Extraction Kit	1	each	2775100
TPH Reagent Set	1	20 cuvettes	2774300
Water, deionized	varies	500 mL	27248

Required apparatus

Description	Quantity/test	Unit	Item no.
Adapter for 12-mm cuvettes	1	each	5954610
Balance, portable, 300 g capacity	1	each	2796900
Caps, flip spout (for 500-mL deionized water bottle)	1	2/pkg	2581802
Marker, laboratory	1	each	2092000
Gloves, nitrile, medium	1	100/pkg	2550502
Pipet, TenSette [®] , 0.1–1.0 mL	1	each	1970001
Pipet tips, for TenSette [®] Pipet, 0.1–1.0 mL	2	50/pkg	2185696
Pipet, Wiretrol [®] , 10–50 µL	1	each	2852200
Pipet, Wiretrol [®] , 50–1000 µL	1	each	2568905
Rack, for 12-mm Micro Cuvettes	1	each	4879910
Safety goggles, vented	1	each	2550700
Soil scoop, 5-g, 4.25-cc	1	20/pkg	2657205
Timer, talking	1	each	2764400
Wipes, disposable	1	280/pkg	2097000
Soil extraction refill kit, for 2775100, includes:	1	each	2775200
Dropper, LDPE, 0.5 and 1.0-mL	1	20/pkg	2124720
Filter and barrel assembly	1	20/pkg	2567620
Sodium sulfate, anhydrous	1	250 g	709929
Soil extraction solution	1	200 mL	2567729
Soil sample container	1	20/pkg	2592920
Weighing boat, 8.9-cm square	1	20/pkg	2179020
Spatula, disposable	1	2/pkg	2569320

Optional reagents and apparatus

Description	Unit	Item no.
Graduated cylinder, 10-mL	each	108138
Sodium Thiosulfate Standard Solution, 0.1 N	100 mL MDB	32332



FOR TECHNICAL ASSISTANCE, PRICE INFORMATION AND ORDERING:
In the U.S.A. – Call toll-free 800-227-4224
Outside the U.S.A. – Contact the HACH office or distributor serving you.
On the Worldwide Web – www.hach.com; E-mail – techhelp@hach.com

HACH COMPANY
WORLD HEADQUARTERS
Telephone: (970) 669-3050
FAX: (970) 669-2932