

Chloramine (Mono) and Nitrogen, Free Ammonia

DOC316.53.01445

Indophenol Method¹

0.04 to 4.50 mg/L Cl₂0.02 to 0.50 mg/L NH₃-N

Method 10200

Powder Pillows

Scope and application: For the determination of free ammonia and monochloramine simultaneously in finished chloraminated water. This product has not been evaluated to test for chlorine and chloramines in medical applications in the United States.

¹ U.S. Patent 6,315,950



Test preparation

Before starting

Always do tests in sample cells. Do not put the instrument in the sample or pour the sample into the cell holder.
Make sure that the sample cells are clean and there are no scratches where the light passes through them.
Rinse the sample cell and cap with the sample three times before the sample cell is filled.
Make sure that there are no fingerprints or liquid on the external surface of the sample cells. Wipe with a lint-free cloth before measurement.
Cold waters can cause condensation on the sample cell or bubbles in the sample cell during color development. Examine the sample cell for condensation or bubbles. Remove condensation with a lint-free cloth. Invert the sample cell to remove bubbles.
Install the instrument cap over the cell holder before ZERO or READ is pushed.
After the test, immediately empty and rinse the sample cell. Rinse the sample cell and cap three times with deionized water.
For the best results, measure the reagent blank value for each new lot of reagent. Replace the sample with deionized water in the test procedure to determine the reagent blank value. Subtract the reagent blank value from the sample results.
Review the Safety Data Sheets (MSDS/SDS) for the chemicals that are used. Use the recommended personal protective equipment.
Dispose of reacted solutions according to local, state and federal regulations. Refer to the Safety Data Sheets for disposal information for unused reagents. Refer to the environmental, health and safety staff for your facility and/or local regulatory agencies for further disposal information.

Items to collect

Description	Quantity
Free Ammonia Chlorinating Solution	1 drop
Monochlor F Reagent Pillows	1
Sample cells, 1-cm/10-mL	2

Refer to [Consumables and replacement items](#) on page 7 for order information.

Sample collection and storage

- Analyze samples immediately after collection.
- Collect samples in clean glass bottles.
- Open the sample valve or spigot and let the water flow for a minimum of 5 minutes.

- Rinse the sample bottle several times with the sample and let the sample overflow each time, then cap the container so that there is no head space (air) above the sample.

Powder pillow procedure

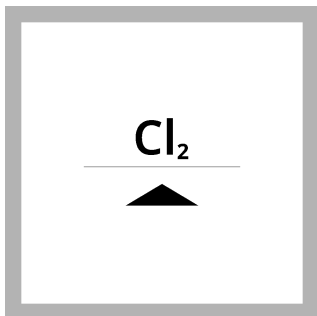

1. Set the instrument to monochloramine (Cl_2). For DR300, push the up arrow button. For PCH, push the menu button, checkmark button, then the menu button again.

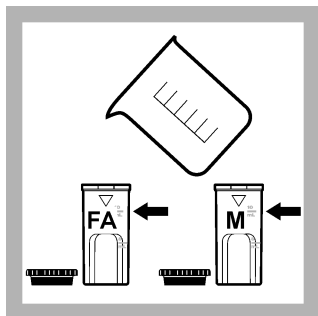

2. Fill two sample cells to the 10-mL line with sample. Write **FA** (free ammonia) on one sample cell. Write **M** (monochloramine) on the second sample cell.

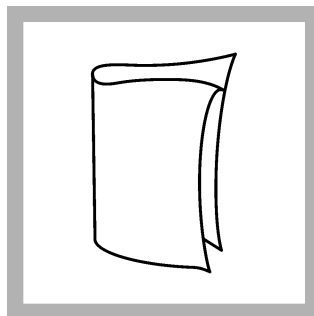

3. Clean the **monochloramine** sample cell.

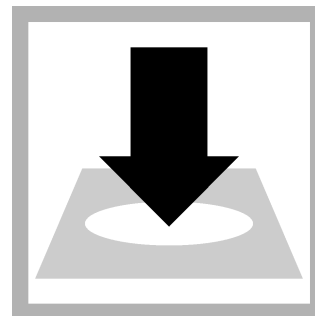

4. Insert the **monochloramine** sample cell into the cell holder. Point the diamond mark on the sample cell toward the keypad.

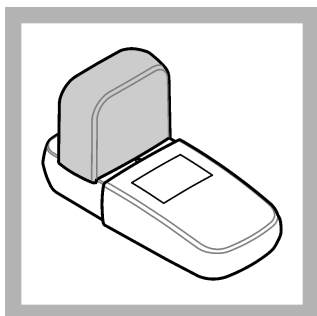

5. Install the instrument cap over the cell holder.

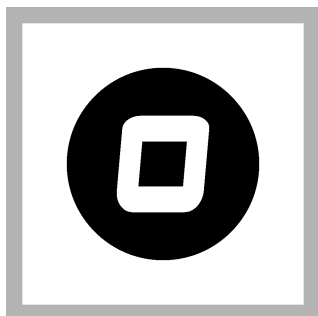

6. Push **ZERO**. The display shows "0.00".

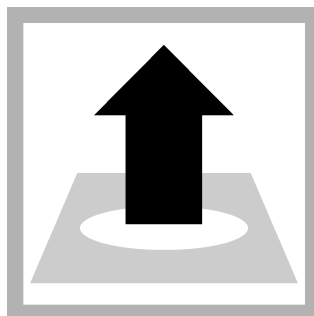

7. Remove the sample cell from the cell holder.



8. Add **1** drop of Free Ammonia Chlorinating Solution to the **free ammonia** sample cell. Close the reagent bottle to keep the reagent stable.

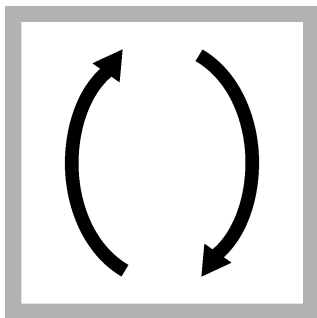

9. Close the **free ammonia** sample cell. Invert the sample cell to mix the reagent for 15 seconds.



10. Set and start a timer for 1 minute. A 1-minute reaction time starts. If the sample pH is more than 9.5, increase the reaction time to 2 minutes. If the sample becomes cloudy by the end of the reaction period, pretreat the sample and start over. Refer to [Interferences](#) on page 4.

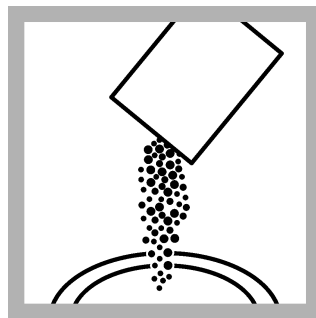

11. Add the content of one Monochlor F Reagent Powder Pillow to each sample cell.

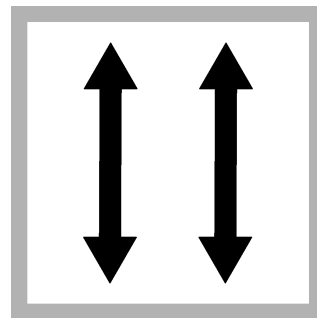

12. Put the stoppers on the sample cells. Shake the sample cells for about **20 seconds** to dissolve the reagent. A green color will show if monochloramine or free ammonia is in the sample.



13. Set and start a timer for 5 minutes. A 5-minute reaction time starts. For samples colder than 18 °C, refer to [Table 1](#) on page 4.

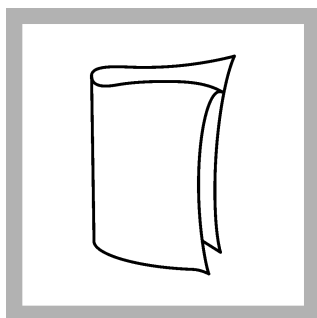

14. When the timer expires, clean the **monochloramine** sample cell. Make sure that there are no air bubbles in the sample cell after the reaction. If there are bubbles, invert the sample cell to remove the bubbles.

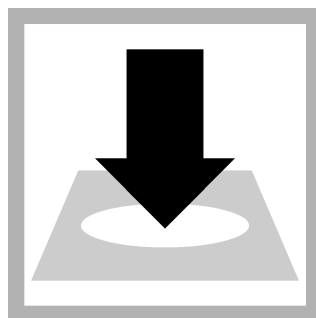

15. Insert the **monochloramine** sample cell into the cell holder. Point the diamond mark on the sample cell toward the keypad.

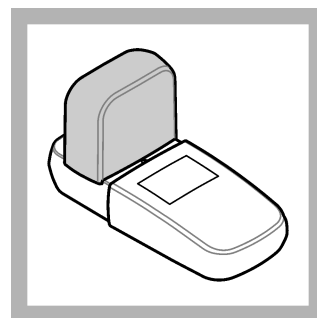

16. Install the instrument cap over the cell holder.

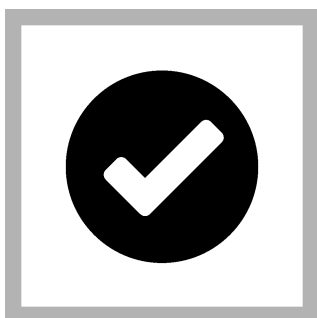

17. Push **READ**. Results show in mg/L monochloramine (as Cl₂).

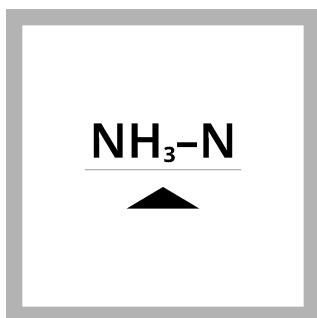

18. Set the instrument to free ammonia (NH₃-N). For DR300, push the up arrow button. For PCII, push the menu button, checkmark button, then the menu button again.

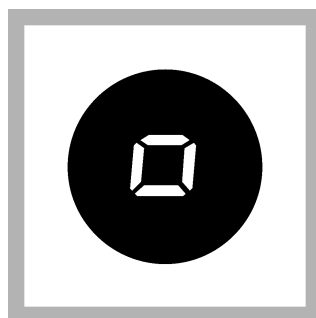

19. Leave the **monochloramine** sample cell in the cell holder. Push **ZERO**. The display shows "0.00".

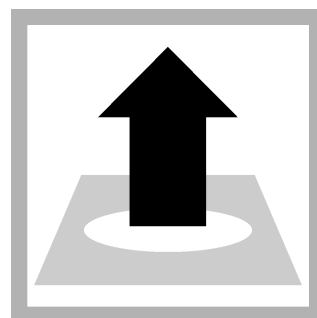

20. Remove the sample cell from the cell holder.

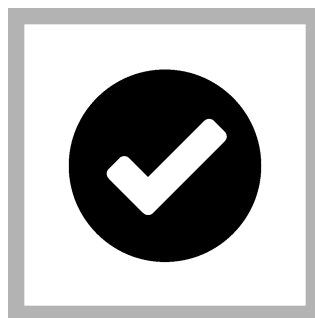
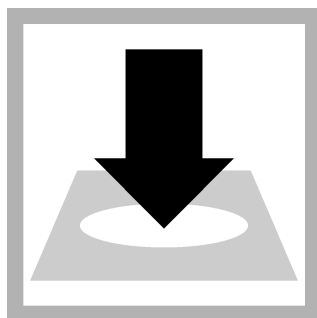
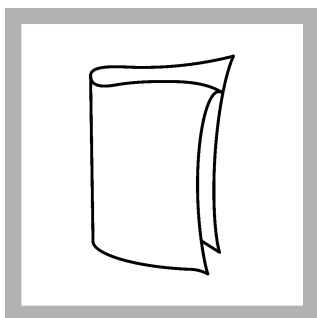

21. Clean the free ammonia sample cell. Make sure that there are no air bubbles in the sample cell after the reaction. If there are bubbles, invert the sample cell to remove the bubbles.

22. Insert the free ammonia sample cell into the cell holder. Point the diamond mark on the sample cell toward the keypad.

23. Push READ. Results show in mg/L free ammonia as nitrogen (NH₃-N).

Color development time

Test results are strongly influenced by the sample temperature. The reaction times in the procedure are for samples at 18–20 °C (64–68 °F). Adjust the reaction times for the sample temperature as shown in [Table 1](#). The color is stable for a maximum of 15 minutes after the specified development time.

Table 1 Color development time

Sample temperature (°C)	Sample temperature (°F)	Development time (minutes)
5	41	10
7	45	9
9	47	8
10	50	8
12	54	7
14	57	7
16	61	6
18	64	5
20	68	5
23	73	2.5
25	77	2
> 25	> 77	2

Interferences

This method is intended for finished, chloraminated drinking water samples that have a measurable combined (total) chlorine disinfectant residual. Samples that do not have a disinfectant residual and samples that have a chlorine demand can cause low ammonia test results. Blanks and ammonia standards that are analyzed without a disinfectant residual must be prepared with high quality, reagent grade water.

The substances that are shown in [Table 2](#) do not interfere in the free ammonia determination at or below the given concentration.

Table 2 Non-interfering substances

Substance	Maximum level tested
Al	0.2 mg/L
Cl ⁻	1200 mg/L
Cu	1 mg/L
Fe	0.3 mg/L
Mn	0.05 mg/L
NO ₃ ⁻ -N	10 mg/L
NO ₂ ⁻ -N	1 mg/L
PO ₄ ³⁻	70 mg/L
SiO ₂	100 mg/L
SO ₄ ²⁻	1600 mg/L
Zn	5 mg/L

Samples that contain high levels of both total hardness and alkalinity may become cloudy after the addition of the Free Ammonia Chlorinating Solution. If this occurs by the end of the first reaction period, the sample for Free Ammonia measurement must be pretreated as follows:

1. Measure 10 mL of sample into the sample cell for Free Ammonia.
2. Add the contents of one Hardness Treatment Reagent Powder Pillow to the sample.
3. Tighten the cap on the sample cell and invert until the reagent is dissolved.
4. Remove the cap.
5. Use the pretreated sample in the test procedure for the Free Ammonia sample.

For samples with a pH less than 8, monochloramine may not form after Free Ammonia Chlorinating Solution is added. If this occurs, add one drop of 1 N Sodium Hydroxide Standard Solution to the sample before Free Ammonia Chlorinating Solution is added. The addition of Sodium Hydroxide Standard Solution increases the pH to appropriate levels to form monochloramine.

Note: The sample for Monochloramine measurement does not need pretreatment.

Accuracy check

Standard solution method

Items to collect:

- Buffer Powder Pillow, pH 8.3
 - Nitrogen, Ammonia Standard Solution, 100 mg/L as NH₃-N
 - Chlorine Solution Ampules, 50–70 mg/L
 - 100-mL Class A volumetric flask
 - 50-mL graduated cylinder
 - Pipet, TenSette®, 0.1–1.0 mL and tips
 - Pipets, Volumetric, 2 mL Class A and Mohr, 5 mL
 - Pipet bulb
 - Organic-free water
1. Prepare a 4.5-mg/L (as Cl₂) monochloramine standard immediately before use as follows.
 - a. Add the contents of one Buffer Powder Pillow, pH 8.3 to approximately 50 mL of organic-free water in a clean 100-mL Class A volumetric flask. Swirl to dissolve the powder.

- b. Use a Class A volumetric pipet to add 2.00 mL of Nitrogen, Ammonia Standard Solution, 100 mg/L as $\text{NH}_3\text{-N}$ into the flask.
 - c. Dilute to the mark with organic-free water. Mix well. This is a 2.00-mg/L buffered ammonia standard.
 - d. Use a graduated cylinder to add 50.00 mL of the buffered ammonia standard into a clean 100-mL beaker. Add a stir bar.
 - e. Find the exact concentration of the Chlorine Solution Ampules, 50–70 mg/L from the label on the package.
 - f. Calculate the volume of the Chlorine Solution to add to the ammonia standard:
 $\text{mL chlorine solution required} = 455/(\text{free chlorine concentration})$.
 - g. Open an ampule and use a glass Mohr pipet to add the calculated amount of Chlorine Solution slowly to the ammonia standard in the beaker. Keep the beaker on a stir-plate at medium speed during the chlorine addition.
 - h. Stir the monochloramine solution for 1 minute after the Chlorine Solution addition is complete.
 - i. Quantitatively transfer the monochloramine solution to a clean 100-mL Class A volumetric flask. Dilute to the mark with organic-free water and mix well. This is a nominal 4.5-mg/L (as Cl_2) monochloramine standard.
2. Use this standard within 1 hour of preparation. Use the test procedure to measure the concentration of the monochloramine standard solution.
 3. Compare the expected result to the actual result.

Note: The factory calibration can be adjusted slightly with the standard calibration adjust option so that the instrument shows the expected value of the standard solution. The adjusted calibration is then used for all test results. This adjustment can increase the test accuracy when there are small variations in the reagents or instruments.

Standard additions method

Use the standard additions method to validate the test procedure, reagents and instrument and to find if there is an interference in the sample.

Items to collect:

- Ammonium Nitrogen Standard Solution, 10 mg/L $\text{NH}_3\text{-N}$
 - 50-mL mixing cylinders (3)
 - Pipet, TenSette[®], 0.1–1.0 mL and tips
1. Prepare three spiked samples: use the TenSette pipet to add 0.3 mL, 0.6 mL and 1.0 mL of the standard solution, respectively, to three 50-mL portions of fresh sample. Mix well.
 2. Use the test procedure to measure the concentration of each of the spiked samples. Start with the smallest sample spike. Measure each of the spiked samples in the instrument.
 3. Compare the expected result to the actual result. The ammonia nitrogen concentration should increase 0.02 mg/L for each 0.1 mL of standard added.

Standard solution method

Use the standard solution method to validate the test procedure, the reagents and the instrument.

Items to collect:

- Ammonium Nitrogen Standard Solution, 10 mg/L $\text{NH}_3\text{-N}$
- 100-mL plastic volumetric flask with stopper, Class A
- 2-mL volumetric pipet, Class A and pipet filler
- Deionized water—must be free of ammonia, chlorine and chlorine demand, for example 18 M Ω -cm water from a deionizer system.

1. Prepare a 0.20 mg/L ammonia nitrogen standard solution as follows:
 - a. Use a pipet to add 2.00 mL of 10 mg/L ammonia nitrogen standard solution into the volumetric flask. (*Alternate preparation: add 0.4 mL of a 50 mg/L ammonia nitrogen standard solution to the volumetric flask.*)
 - b. Dilute to the mark with deionized water. Mix well. Prepare this solution daily.
2. Use the test procedure to measure the concentration of the prepared standard solution.
3. Compare the expected result to the actual result.

Note: The factory calibration can be adjusted slightly with the standard calibration adjust option so that the instrument shows the expected value of the standard solution. The adjusted calibration is then used for all test results. This adjustment can increase the test accuracy when there are small variations in the reagents or instruments.

Method performance

The method performance data that follows was derived from laboratory tests that were measured on a DR300 and a Pocket Colorimeter II during ideal test conditions. Users can get different results under different test conditions.

Precision (95% confidence interval)
Standard deviation of ± 0.005 mg/L $\text{NH}_3\text{-N}^1$

Summary of method

Monochloramine (NH_2Cl) and free ammonia (NH_3 and NH_4^+) can exist in the same water sample. Added hypochlorite combines with free ammonia in the sample to form more monochloramine. In the presence of a cyanoferrate catalyst, monochloramine in the sample reacts with a substituted phenol to form an intermediate monoimine compound. The intermediate couples with excess substituted phenol to form a green-colored indophenol, which is proportional to the amount of monochloramine present in the sample. Free ammonia is determined by comparing the color intensities, with and without added hypochlorite.

Consumables and replacement items

Required reagents

Description	Quantity/test	Unit	Item no.
Free Ammonia Reagent Set, includes:	—	50/pkg	2879200
Free Ammonia Chlorinating Solution	1 drop	4 mL SCDB	2877436
Monochlor F Reagent Pillows	2	100/pkg	2802299

Required apparatus

Description	Quantity/test	Unit	Item no.
Sample cells, 1-cm/10-mL	2	2/pkg	4864302

Recommended standards and apparatus

Description	Unit	Item no.
Buffer Powder Pillows, pH 8.3	25/pkg	89868
Chlorine Standard Solution, 10-mL Voluette [®] Ampule, 50-75 mg/L	16/pkg	1426810

¹ In a single laboratory, using a solution with 1.59 ppm Monochloramine as chlorine and 0.14 ppm free $\text{NH}_3\text{-N}$ and one representative lot of reagent was measured nine times with a DR300, a single operator obtained a standard deviation of ± 0.005 mg/L $\text{NH}_3\text{-N}$ for nine replicates.

Recommended standards and apparatus (continued)

Description	Unit	Item no.
Chlorine Standard Solution, 2-mL PourRite [®] Ampule, 50-75 mg/L	20/pkg	1426820
Chlorine Standard Solution, 2-mL PourRite [®] Ampules, 25–30 mg/L	20/pkg	2630020
Hardness Treatment Reagent Pillows	50/pkg	2882346
Nitrogen Ammonia Standard Solution, 10-mg/L NH ₃ -N	500 mL	15349
Nitrogen Ammonia Standard Solution, 10-mL Voluette [®] Ampule, 50-mg/L NH ₃ -N	16/pkg	1479110
Nitrogen Ammonia Standard Solution, 100-mg/L as NH ₃ -N	500 mL	2406549
PourRite [®] Ampule Breaker, 2-mL	each	2484600
Ampule Breaker, 10-mL Voluette [®] Ampules	each	2196800
Water, organic-free	500 mL	2641549

Optional reagents and apparatus

Description	Unit	Item no.
Beaker, 100 mL, polypropylene	each	108042
Beaker, glass, 100 mL	each	50042H
Mixing cylinder, graduated, 50 mL	each	2088641
Flask, volumetric, Class A, 100 mL, glass	each	1457442
Monochloramine/Free Ammonia SpecCheck [™] Kit	each	2507500
Pipet filler, safety bulb	each	1465100
Pipet, TenSette [®] , 0.1–1.0 mL	each	1970001
Pipet tips for TenSette [®] Pipet, 0.1–1.0 mL	50/pkg	2185696
Pipet tips for TenSette [®] Pipet, 0.1–1.0 mL	1000/pkg	2185628
Pipet, Mohr, glass, 10-mL	each	2093438
Pipet, volumetric, Class A, 2 mL	each	1451536
Pipet, volumetric, Class A, 50 mL	each	1451541
Scissors	each	2883100
Stir bar, octagonal	each	2095352
Stirrer, magnetic	each	2881200
Thermometer, –10 to 110 °C	each	187701
Wipes, disposable	280/pkg	2097000



FOR TECHNICAL ASSISTANCE, PRICE INFORMATION AND ORDERING:
 In the U.S.A. – Call toll-free 800-227-4224
 Outside the U.S.A. – Contact the HACH office or distributor serving you.
 On the Worldwide Web – www.hach.com; E-mail – techhelp@hach.com

HACH COMPANY
 WORLD HEADQUARTERS
 Telephone: (970) 669-3050
 FAX: (970) 669-2932